

[pro]master®

PROFESSIONAL

FL1

Professional Electronic

Flash



INTRODUCTION

Thank you for your purchase of the ProMaster FL1 Professional Flash.

This advanced digital flash provides a variety of automatic and manual features that allows you maximum creativity and flexibility in your flash photography.

Please take a few minutes to read this instruction manual and familiarize yourself with the features and benefits of the FL1 flash.

COMPATIBILITY

The ProMaster FL1 flash is available to fit a variety of camera makes. Please find the model below that fits your camera.

Code 1240: For Canon DSLR & digital E-TTL, E-TTL II cameras & E-TTL film cameras

Code 1247: For Nikon DSLR & digital TTL, i-TTL cameras & TTL, i-TTL film cameras

Code 1254: For Pentax P-TTL DSLR, digital & film cameras

Code 1261: For Olympus and Panasonic DSLR & digital TTL cameras

Code 1268: For Sony Alpha ADI system DSLR, digital & TTL film cameras

ONE YEAR UNCONDITIONAL GUARANTEE

If for any reason, this ProMaster product fails within ONE YEAR of the date of purchase, return this product to your ProMaster dealer and it will be exchanged for you at no charge.

ProMaster products are guaranteed for ONE FULL YEAR against defects in workmanship and materials. If at any time after one year, your ProMaster product fails under normal use, we invite you to return it to ProMaster for evaluation.

FEATURES

- Auto and manual zoom from 24-28-35-50-70-85-105mm
- TTL metering
- Wireless TTL function
- High speed synchronization
- 7 levels of power ratio 1/1, 1/2, 1/4, 1/8, 1/16, 1/32 & 1/64
- 2" LCD Control Panel
- Secondary fill flash
- Focus assist beam for low light focusing
- Front and rear curtain synchronization
- Slow synchronization
- Red eye reduction pre-flash (for Nikon, Olympus-Panasonic and Pentax mount)
- Built-in optical slave sensor
- Power save function
- Detachable wide angle diffuser
- Firmware upgrade possible

OVERVIEW - FRONT

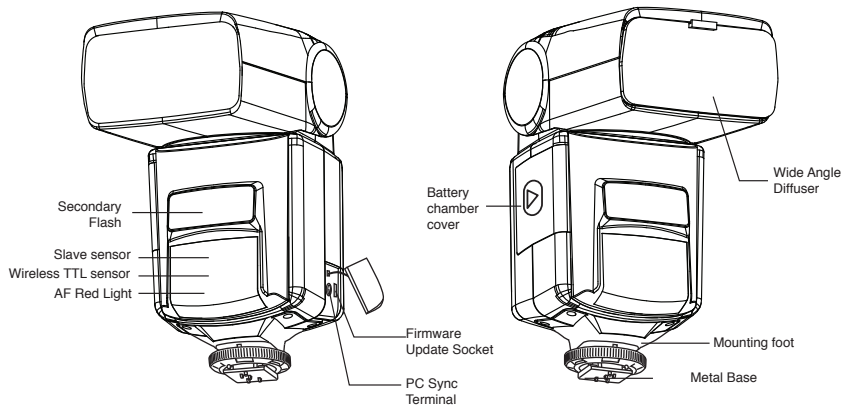

OVERVIEW - BACK

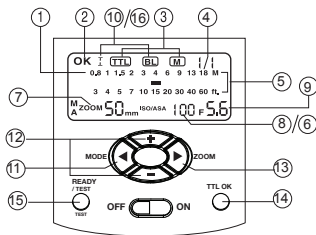
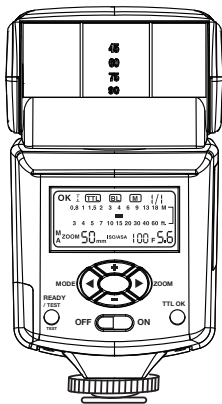

1. LCD Display
2. Exposure Confirmation Indicator
3. Flash Mode Indicator
4. Manual Mode Output Power Indicator
5. Flash Range Distance Indicator
6. Power Save / Secondary Flash Indicator
7. Zoom Indicator
8. Film Speed Indicator
9. f-Stop Indicator
10. iTTL / BL Indicator (for Nikon only)
11. Mode Selection Button
12. + / - Button
13. Zoom Position Selection Button
14. Exposure OK Light
15. Ready Light / Test Button
16. High Speed Sync / Slave Mode Indicator

POWER ON / OFF SWITCH

OFF  ON Type C/N/OP/SA

OFF  ON Type P

SAFETY INSTRUCTIONS

Before using this flash, please read the instructions below to ensure safe use and avoid unnecessary damage to the flash and injury to yourself and others:

- Do not fire flashes from a short distance directly into the eyes of people or animals. This can cause damage to the retina and may even lead to blindness.
- Always use batteries of the same type, brand, and age. Do not combine different types, brands, old, or new batteries. This could cause the batteries to overheat, leak, or explode.
- Install the batteries in proper orientation as indicated in the battery chamber. Installing the batteries in reverse orientation could cause the batteries to overheat, leak, or explode.
- Always switch off the flashgun before changing the batteries.
- Do not attempt to open the flashgun because the electronic circuit contains high voltage.
- If the flashgun is badly damaged and internal components are exposed, remove the batteries from the flash. Contact customer service. Never try to repair the flashgun by yourself.
- This product is not water-resistant. Keep it away from rain, snow, and high humidity areas.
- Do not clean the flash with agents containing corrosive or flammable substances. Also, do not store or use the flash in flammable conditions.

INSTALLING BATTERIES

To install batteries, make sure that the flash is turned off and follow the steps below:

- Slide the battery chamber door in the direction of the arrow to remove it;
- Insert the batteries in the orientations as indicated in the battery chamber;
- Slide the battery chamber door back into place, in the opposite direction of the arrow.

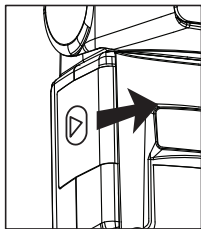

1

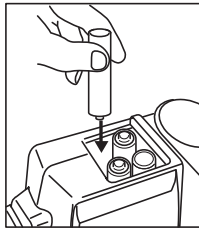

2

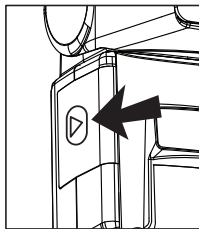

3

MOUNTING AND REMOVING THE FLASH FROM THE CAMERA

• FOR Canon, Nikon, Pentax and Olympus/Panasonic flash

(1) Mounting the flash

With the back of the flash facing you, loosen the locking ring by turning it to the right until you can easily slide the flash forward into your camera's hot shoe. Then tighten the locking ring by turning it to the left until the flash is firmly mounted onto the camera.

(2) Removing the flash

Carefully turn the locking ring to the right so it becomes loose. Once you can no longer easily turn the locking ring, slide the flash towards you to remove the flash from the camera's hot shoe.

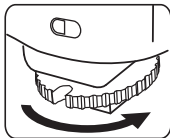

1a

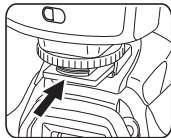

1b

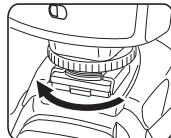

2

MOUNTING AND REMOVING THE FLASH FROM THE CAMERA

• FOR Sony flash

(1) Mounting the flash

Ensure the PUSH button is not pressed into the flash. Slide the mounting foot all the way into the camera's hot shoe. The lock will automatically engage and hold the flash in place. A safety catch can be heard.

(2) Removing the flash

Press the PUSH button inside and downward while simultaneously sliding the flash away from the camera's hot shoe. After removing the flash from the camera, make sure you release the PUSH button so that it is not pressed into the flash.

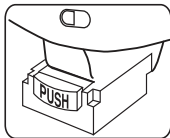

1a

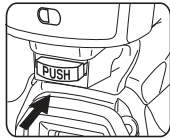

1b

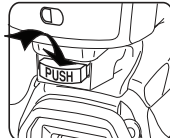

2

TO TEST THE FLASH

Turn on the flash by sliding the ON / OFF switch to the ON position.

The READY indicator will glow red when the flash is ready to fire. If the flash is mounted onto the camera, a flash icon will appear in the camera's viewfinder.

Press the READY/Test button to fire a test flash to ensure the flash works properly. When the ready indicator glows again, the flash is ready to fire.

SELECTING THE FLASH MODE

The ProMaster FL1 offers "TTL", "Manual", "Slave", "Wireless TTL", "Sub Flash", and "High Speed Sync" flash modes.

To change between different modes, press the MODE button on the LCD panel and the flash mode will change in the following sequence: TTL ▶ M (Manual) ▶ S (Slave) ▶ STTL (Wireless TTL) ▶ Sub Flash (Sub) ▶ H (High Speed Sync, only available in C/OP/P/SA flash) ▶ back to TTL

To choose your desired mode, press the MODE button until the corresponding indicator appears on the LCD. When you press the MODE button, or any other buttons on the back panel, the LCD will illuminate for approximately 5 seconds.

TTL FLASH MODE

When your flash is mounted to a compatible camera, the ProMaster FL1 flash's advanced programming and computerized circuitry will produce the correct exposure using the camera's TTL metering data.

To use the TTL mode, follow the steps below:

- (1) The camera should be set to P, Auto, or any priority mode such as aperture-priority.
 - (2) When you first power the flash unit, it will automatically be set to TTL mode, and the "TTL" indicator will be visible on the LCD. If the flash has been set to another mode, press the MODE button repeatedly until the "TTL" indicator shows on the LCD.
 - (3) Press the shutter release button on your camera halfway to ensure that the camera is communicating with the flash. The camera's ISO and aperture setting will be displayed on the flash's LCD, and a flash icon will appear in the camera's viewfinder.
 - (4) Make sure that the subject is not farther away than the suggested distance indicated on the LCD.
 - (5) Press your camera's shutter release button fully to take the picture. An 'OK' indicator will show up momentarily on the LCD. The green OK light will also glow to indicate that a proper exposure has been attained.
- **FOR NIKON flash:** The LCD will show TTL, I-TTL or BL depending on your camera model. Please refer to your camera's instruction manual for details.
 - The ISO and aperture indication on this flash provide readouts up to ISO 800 and f/11 in full-stop increments. The indicator will show the ISO number and f/stop value closest to your current camera settings.

HIGH SPEED SYNC

The ProMaster FL1 will allow the use of shutter speeds higher than your camera's top flash sync speed in TTL mode by activating the High Speed Sync. This allows you to use shutter speeds as fast as 1/8000 second. The use of High Speed Sync is particularly useful when using large apertures in bright situations or freezing motion.

• FOR Nikon flash

The High-Speed Sync is automatically set by the camera. No special operation on the flash is required. Please consult your camera's manual for details.

• FOR Canon, Pentax, Sony, or Olympus/Panasonic flash

- (1) Press the MODE button until you reach the high speed sync mode. The "H" indicator will show on the LCD.
- (2) Press the "+" or "-" selector button to toggle between On and Off status. The setting will automatically be saved into the internal memory.

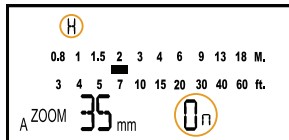



FRONT AND REAR CURTAIN SYNC

When you take photos of a moving subject using a slow (1/30 second or longer) shutter speed and a flash, the flash will freeze the subject and the long exposure will cause light trails and motion blur to appear in the image. This technique, referred to as slow sync, can be achieved in the following ways:

The 'front-curtain' or 'first-curtain' sync allows you to synchronize the flash with the camera's shutter release so that the flash fires at the instant the front curtain has fully opened. This causes the light trails and motion blur to appear ahead of the moving subject.

The 'rear-curtain' or 'second-curtain' sync synchronizes the flash so that the flash fires just before the second curtain closes. This freezes motion at the end of the exposure and creates light trails and motion blur effect behind the main subject.

• **FOR Pentax flash**

You can select the sync mode as either front-curtain () or rear-curtain () using the POWER switch of the flash. The flash will fire according to the mode selected.

• **FOR all other models of flash**

The camera controls the sync mode, therefore no setting is required on the flash. Please consult your camera's instruction manual to determine how to set this feature on your camera.

RED EYE REDUCTION

"Red-eye" occurs when the light from the flash reflects off of the retinas in your subject's eyes.

Many cameras include a "red-eye reduction" feature. When this feature is activated, the camera will instruct the flash to fire pre-flashes before the picture is taken to help eliminate the red eye effect.

The ProMaster FL1 flash supports your camera's red-eye reduction function. Please refer to your camera's instruction manual for details on how to activate it.

AUTOFOCUS ASSIST LIGHT

In low light situations, a camera's auto focus system can have difficulty locking focus on the subject. When the ambient light level is low, the ProMaster FL1 flash emits a red autofocus assist beam when the camera's shutter release button is pressed halfway. This assist beam will help your camera's autofocus system to achieve focus lock.

Not all camera's autofocus modes work with an external autofocus assist beam for focusing. Please check your camera's instruction manual to find out more.

MANUAL MODE

You can set the ProMaster FL1 flash's output level manually to create special lighting effects. Seven manual settings are available: 1/1, 1/2, 1/4, 1/8, 1/16, 1/32, and 1/64. The flash fires full power at the 1/1 setting, and each successive setting halves the light output. To use the manual mode:

- (1) Press the MODE button until you reach the manual mode. The “M” indicator will show on the LCD.
- (2) Then press the “+” or “-” selector button to set your desired output. The setting will then be automatically saved into the internal memory.
- (3) Set your camera accordingly. For shutter speed, the highest you can set is the camera's flash sync speed unless you activate the High Speed Sync feature. Please refer to the section “HIGH SPEED SYNC” for details.
- (4) Make sure that your subject is within the suggested maximum flash-to-subject distance as indicated on the LCD and take a test shot. Check the result on your camera.
- (5) Adjust your camera's setting and the level of the light output of the flash if needed.
- (6) Press the camera's shutter release button to take the picture.

To avoid overheating or damage to the flash, please wait for at least 10 minutes after making 15 continuous shots at full power. Your flash will automatically shut off if overheated.

AUTOMATIC MOTOR ZOOM CONTROL

The ProMaster FL1 flash supports automatic motor zoom control with cameras allowing digital data transmission to the flash. The available zoom positions are 24, 28, 35, 50, 70, 85, and 105mm.

When you turn the flash on, the zoom mode indicator on the LCD will display an “A” indicating that automatic motor zoom head control is activated and zoom head is at the default 35mm position.

When the camera's shutter release is pressed half way, the flash zoom head will adjust to match the focal length of the lens, and the closest zoom setting will be displayed on the LCD. When you change the lens focal length, the flash zoom setting will change accordingly.

When the flash head is tilted or swiveled to the side, the flash zoom setting will be automatically set to 50mm.

MANUAL ZOOM CONTROL

You can adjust the flash zoom setting independent of the focal length of the lens. Press the ZOOM button to make the “M” indicator to appear. Then continue to press to cycle through the available focal length settings.

WIDE ANGLE DIFFUSER

If your camera lens is wider than 24mm full frame/16mm digital, you can use the provided wide angle diffuser to extend the flash's angle of coverage to 18mm full frame/12mm digital.

To install the diffuser:

- (1) Make sure that the snap is facing downward. Hold the diffuser at the attachment clip. Slide the bottom of the diffuser into the lower side of the flash head;
- (2) Press the diffuser into the flash head and it will snap into place.

To remove the diffuser from the flash head, just hold the diffuser at the attachment clip and then pull the diffuser out.

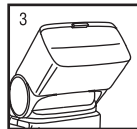
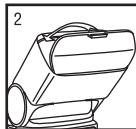
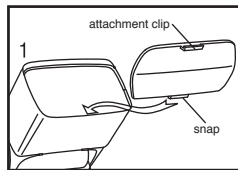

INDIRECT LIGHTING TECHNIQUES

Using direct flash to illuminate a subject may result in images that have unattractive shadows. The ProMaster FL1 allows you to tilt the flash head to an angle of -7° , 45° , 60° , 75° , or 90° and/or rotate it horizontally 180° to the left and 120° to the right allowing for softer lighting options.

Tilting the flash head or swiveling it to the side allows you to bounce the light off the ceiling or walls. While shooting indoors, this technique can help to create more natural-looking pictures of people with softer shadows. When the flash head is tilted or rotated to the side, the flash zoom setting will be locked to 50mm. You may need to adjust your camera's settings (such as the aperture value), since the light falling on the subject will be reduced. You can change the zoom setting by pressing the ZOOM button until you achieve the desired position.

Bouncing the flash off a white or neutral-colored surface will not alter the color of the light. Bouncing the flash off a colored surface can create a color cast in your images. Bouncing the flash off a gold-toned surface can give the portraits a warmer look. Other colors can be used for creative effects.

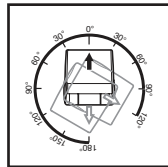
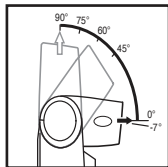

When the flash-to-subject distance is less than 2m (6.6ft), tilt the flash head down to ensure sufficient illumination of the lower part of the subject. The ProMaster FL1 allows you to tilt the head down -7° to achieve this purpose.

• SUB flash

Using bounce flash may still cause unwanted shadows on your portraits. The ProMaster FL1 features a small secondary flash below the main flash which provides a fill-in light to help reduce shadows.

To activate or deactivate the secondary flash, press the MODE button until the “ --- ” indicator shows up on the LCD. Then press the “ + ” or “ - ” button to toggle between the “Sub On” and “ --- ” (Sub Off) status.

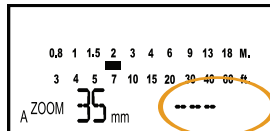

• Sub flash deactivated

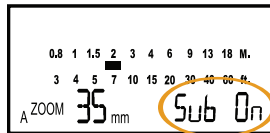

• Sub flash activated

• SUB flash (cont'd)

After you have activated the secondary flash, it may be used in the TTL, Manual, or Slave mode. Press the MODE button until you enter your desired flash mode. Make sure that the correct mode indicator is displayed on the LCD. The “Sub” indicator will be displayed at the bottom right of the LCD if the secondary flash is activated.

Please note that when the flash head is not in one of the bounce or swivel positions, or when the high speed sync is activated, the secondary flash will be turned off automatically. The “Sub” indicator will not appear on the LCD.

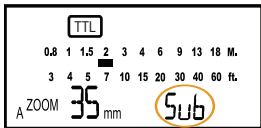

• TTL mode display when sub flash is activated



• Manual mode display when sub flash is activated

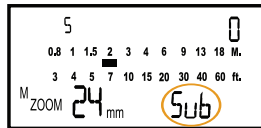

• Slave mode display when sub flash is activated

MANUAL SLAVE FLASH

You can use the ProMaster FL1 off of the camera as a manual slave unit by activating the optical slave feature. When this feature is activated, the flash will fire whenever it “sees” another flash firing. This works optically, using the built-in optical slave sensor. To use as a manual slave flash:

- (1) Press the MODE button until you enter Manual mode. The “M” indicator will show on the LCD.
- (2) Select your desired power level by pressing the “ + ” or “ - ” button. The setting will be automatically saved into the memory.
- (3) Then press the MODE button till you enter Slave mode. The “S” indicator will show on the LCD.
- (4) Press the “ + ” or “ - ” button to set the appropriate slave setting 0, 1, or 2 (please refer to the next section for details).
- (5) You may also want to adjust the flash coverage angle. Do this by pressing the ZOOM button to manually select the desired focal length for the zoom head.
- (6) Finally, make sure that the master flash is on and set up correctly. Fire the master flash and the slave flash will fire with the master flash’s main flash.

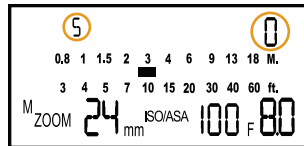

CHOOSING THE MANUAL SLAVE MODE

Your Master Flash (the flash used to trigger the slave) may emit more than one burst of light in quick succession before the main flash. These are called pre-flashes, which are controlled by the camera and fired to help the camera to determine the correct exposure for the photograph or to reduce the "red-eye" effect. If the slave flash is not set to the correct mode, it may fire before the camera's shutter opens. To ensure that the slave flash fires at the correct time, there are three slave modes available in this flash to help you to synchronize with the master flash:

- Mode 0 The slave flash fires instantly when it "sees" the first light burst from the master flash
- Mode 1 & 2 The slave flash ignores 1 (Mode 1) or 2 (Mode 2) pre-flashes. These modes should be used when the master flash is set to TTL or any automatic modes. Always take a test shot to check which mode you should use in order to synchronize the slave flash with the master flash's main flash.

If you are using your camera's built-in flash or an external flash attached to the camera as the master flash, you should note that this flash may emit a series of quick flashes lasting for a second or more when the camera's red eye reduction feature is activated. As a result, no appropriate slave modes can be selected for synchronization. You should turn off the red eye reduction feature in your camera when using this flash as a slave flash.

WIRELESS TTL SLAVE OPERATION

The ProMaster FL1 is equipped with advanced wireless TTL flash feature, so that it can be used off camera while still maintaining full TTL control. Take a moment to familiarize yourself with the following terms in order to understand how to work with multiple wireless TTL flash units:

| | |
|-----------------------|---|
| Master | This can be the camera's built-in flash, a flash mounted on the camera, or a dedicated wireless controller. Only one master flash is allowed in a wireless multiple flash photography setting. It controls how the slave flashes operate in wireless TTL mode. |
| Remote or Slave Flash | Flash units that are not directly connected to the camera, and are controlled by a master flash or controller are called "slave" or "remote" units. There is no limitation on the number of remote units that can be used at one time. |
| Channel | Master and Slave units exchange data through channels. Four channels (1, 2, 3, 4) are available in the flash. You can pick the channel you prefer for communication between the master and remote flash units. You can use this option to prevent your remote flash units from being triggered by the master unit of another photographer working with the system nearby. |
| Group | You can assign remote flash units to one of the three groups (A, B, or C) and set the mode and output power level of each group. |

To use this flash as Wireless TTL slave flash:

- (1) Make sure that the master flash or controller is on and set to TTL automatic mode.
- (2) Set the setting for each group of flash units in the master flash or controller. Assign the master to one of the channels. Please refer to your master flash's manual on how to do this.
- (3) Press the MODE button of this flash until you reach the Wireless TTL mode. The "STTL" indicator will show on the LCD. Then press the "+" or "-" button to cycle through the available channels and groups.
- (4) Select the channel that matches your master flash or controller.
Each time you press the "+" button, the channel and group setting will change in the following sequence: 1A ▶ 1B ▶ 1C ▶ 2A ▶ 2B ▶ 2C ▶ 3A ▶ 3B ▶ 3C ▶ 4A ▶ 4B ▶ 4C
- (5) The setting will automatically be saved into the internal memory of the flash. You will notice that the front red light blinks, indicating that the flash is now in Wireless TTL mode.
- (6) You may want to adjust the flash coverage. To do this, use the ZOOM button.

SLAVE FLASH SETUP

You can create a professional lighting setup by putting slave flash units into different groups to function as main, fill, accent, side, or other lights. Set the output power level of each group appropriately to achieve specific effects for your photographs.

While positioning the slave flash units, please keep in mind the following points:

- (1) The effective shooting distance between the master and remote flash units is approx. 10m (33 ft.) or less in the front position, and approx. 5 to 7m (16 to 23 ft.) at both sides. These ranges may vary depending on the ambient light.
- (2) Make sure that the TTL sensor (when using wireless TTL mode) or the optical slave sensor (when using the manual slave mode) of the slave flash units are facing the master flash or controller, and there is no obstruction in between.

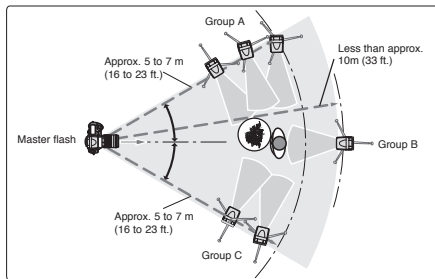

- (3) When taking pictures outdoors or under bright ambient light, the sensitivity of the sensors may be reduced.
- (4) To avoid interference between flash units, using more than three flashes in a group is not recommended.
- (5) Avoid aiming the flash directly into the camera lens.

PC SYNC TERMINAL

The ProMaster FL1 can be used with cameras without a hot shoe. Some cameras have an x-terminal to allow flash synchronization. You can connect this flash's PC Sync Terminal to the camera's x-terminal using a sync cord to enable the camera to trigger this flash.

FLASH EXPOSURE COMPENSATION

In TTL mode, you can apply flash exposure compensation by pressing the flash exposure compensation button on your camera and adjust the flash exposure level up and down with your camera's controls.

The range and control of flash exposure compensation vary between different camera models. Consult your camera manual for more information about this feature.

POWER SAVE MODE

If there is no communication between the flash and the camera for approximately 3 minutes, the flash will automatically enter power save mode to conserve battery power. In this mode, "OFF" will appear on the LCD. The Ready light will be off in power save mode.

To reactivate the flash, press any button on the LCD panel or the camera's shutter release button. If you are not going to use your flash for an extended period, we recommend that you power the flash off completely, using the power switch.

FIRMWARE UPGRADE

The firmware of the ProMaster FL1 can be upgraded to allow compatibility with future camera releases. For more details on the upgrade of the firmware, please contact your local dealer.

GUIDE NUMBER CHART (AT ISO 100)

| Zoom Position (mm) | GN - Feet | GN - Meters |
|--------------------|-----------|-------------|
| 24 | 121 | 37 |
| 28 | 131 | 40 |
| 35 | 141 | 43 |
| 50 | 151 | 46 |
| 70 | 161 | 49 |
| 85 | 174 | 53 |
| 105 | 180 | 55 |

SPECIFICATIONS

Type: On-Camera and Wireless TTL Automatic and Manual Flash with Secondary Fill-in Flash

Guide No: 55(m) / 180(ft) at 105mm position and ISO 100

Full Frame Flash Coverage: 24 - 28 - 35 - 50 - 70 - 85 - 105mm (18mm with wide angle diffuser)

High Speed Synchronization: Yes

Flash Recycle Time and Duration: 0.5 - 9 seconds with duration from 1/20,000 - 1/1,000 second

Manual Mode Power Output: 1/1, 1/2, 1/4, 1/8, 1/16, 1/32 & 1/64

Wireless Transmission Method and Range: Optical Pulse up to 10 meters (33 feet)

Wireless Channels and Groups: 3 Channels and 4 Groups

Slave Modes: Instant Sync, Skip one flash, Skip two flashes (S0, S1, S2)

PC Sync Terminal: Yes

Power Source: 4 AA Alkaline, Ni-MH, or Lithium batteries

Bounce/Tilt Range: Up 45°, 60°, 75°, 90°; Down -7°; Right 0° - 120°; Left 0° - 180°

Dimensions (W x L x H): Approx. 75 x 110 x 130 mm / 2.95 x 4.33 x 5.12 inches

Weight (without batteries): Approx. 300 grams / 10.58 ounces

Included Accessories: Flash Stand, Pouch, Wide Angle Diffuser Panel



[pro]master®